

modello A 300

MinoEdge
www.minoedge.it

CENTRO PRENOTAZIONI
0421 290573

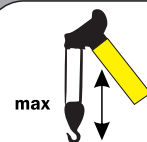
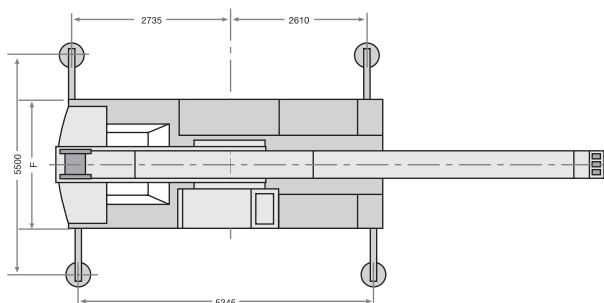
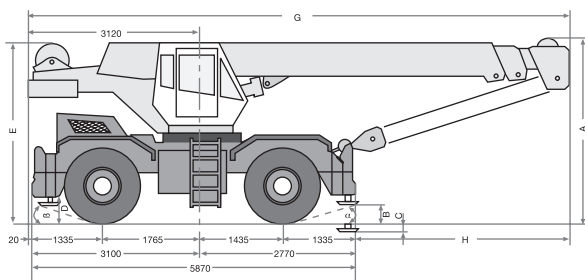
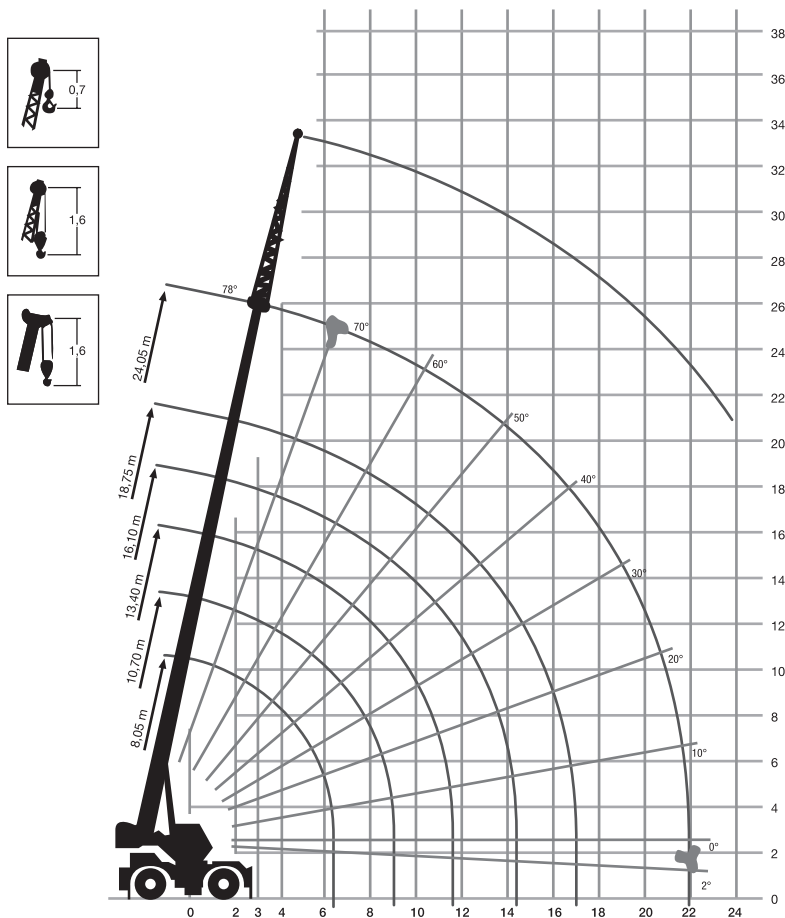

24,00

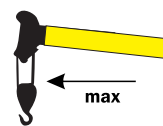

22,00

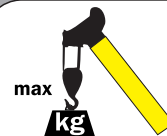

30 TON

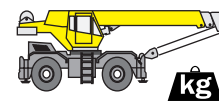

24 TON

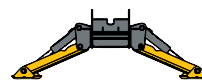

5500X5345

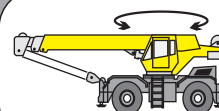

360°

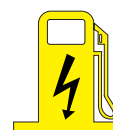

DIESEL

GRU FUORISTRADA

modello A 300

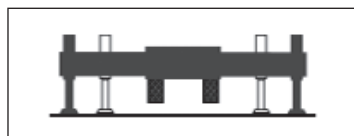

5.50 m

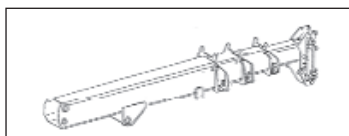



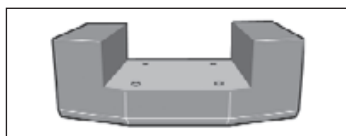





8.05 m ÷ 24.05 m



4.20 t



360°

							
	8.05 m	10,70 m	13,40 m	16.10 m	18.75 m	24.05 m	
							
3.0	30.00	23.00	21.00	19.00			3.0
3.5	25.00	23.00	20.00	18.60			3.5
4.0	22.50	22.50	20.00	16.90	13.80		4.0
4.5	20.00	20.00	18.50	15.00	13.00		4.5
5.0	18.00	18.00	17.00	14.00	12.50	8.40	5.0
6.0	14.50	14.50	14.00	12.10	11.00	8.00	6.0
7.0		11.20	11.20	10.60	9.50	7.00	7.0
8.0		8.90	8.90	8.90	8.30	6.30	8.0
9.0			7.50	7.50	7.20	5.80	9.0
10.0			6.30	6.30	6.30	5.60	10.0
11.0			5.10	5.10	5.10	4.70	11.0
12.0				4.40	4.40	4.20	12.0
13.0				3.70	3.70	3.80	13.0
14.0				3.30	3.30	3.50	14.0
15.0					2.90	3.10	15.0
16.0					2.60	2.80	16.0
17.0					2.30	2.40	17.0
18.0						2.30	18.0
19.0						2.10	19.0
20.0						1.70	20.0
21.0						1.60	21.0
22.0						1.50	22.0
23.0							23.0
24.0							24.0