

# modello A 350

**MinoEdge**  
www.minoedge.it

CENTRO PRENOTAZIONI  
**0421 290573**

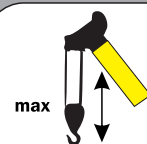
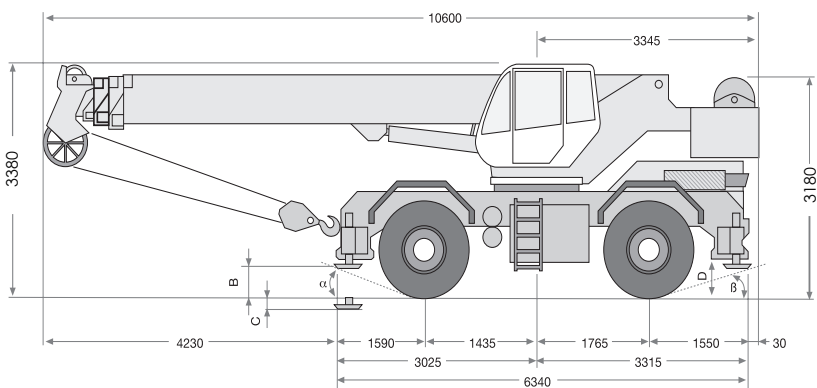
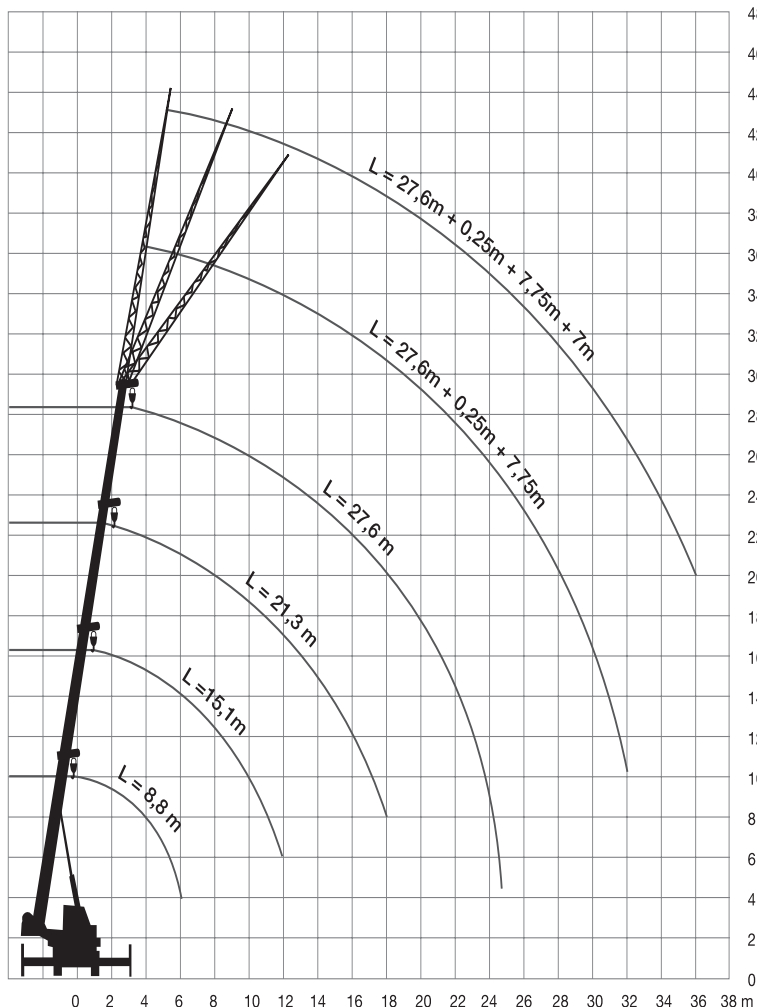

30,00 GRU  
42,00 GRU + JIB

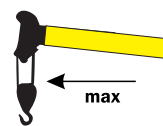

26,00 GRU  
38,00 GRU + JIB

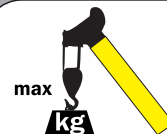

30 TON

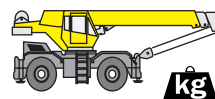

25,5 TON

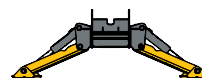

5.830 max

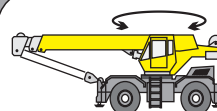



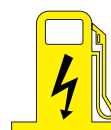

360°











DIESEL





## GRU FUORISTRADA









# modello A 350

				
5.80 m	8.80 m ÷ 27.60 m	4.90 t	360°	

								
	8.80 m	12.00 m	15.10 m	18.20 m	21.30 m	24.50 m	27.60 m	
								
3.0	30.00	22.60	22.50	21.20				3.0
3.5	28.00	22.60	22.50	19.30				3.5
4.0	25.20	22.60	20.80	17.40	15.50	12.35		4.0
4.5	23.00	22.60	18.90	16.00	14.20	11.50		4.5
5.0	20.50	20.00	17.30	14.70	13.10	10.70		5.0
6.0	16.20	16.30	15.00	12.60	11.30	9.45	8.85	6.0
7.0		12.05	12.10	11.00	9.95	8.40	7.90	7.0
8.0		9.45	9.50	9.50	8.80	7.55	7.10	8.0
9.0		7.65	7.70	7.70	7.70	6.85	6.45	9.0
10.0			6.40	6.40	6.45	6.20	5.85	10.0
11.0			5.40	5.45	5.45	5.20	5.20	11.0
12.0			4.65	4.65	4.70	4.50	4.50	12.0
13.0			4.00	4.05	4.05	3.80	3.80	13.0
14.0				3.55	3.55	3.40	3.40	14.0
15.0				3.10	3.15	2.90	2.90	15.0
16.0				2.75	2.75	2.60	2.60	16.0
17.0					2.45	2.30	2.30	17.0
18.0					2.20	2.00	2.00	18.0
19.0					1.70	1.80	1.80	19.0
20.0						1.60	1.60	20.0
21.0						1.40	1.40	21.0
22.0						1.25	1.20	22.0
23.0							1.10	23.0
24.0							1.00	24.0
25.0							0.80	25.0
26.0								26.0







# modello A 350



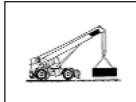
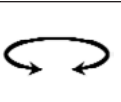

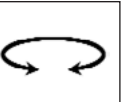





				
5.80 m	24.05 m ÷ 27.60 m	4.90 t	360°	8.0 m / 15 m







	24.05m + 8.0 m	27.60m + 8.0 m	27.60m + 8.0 m	27.60m + 8.0 m	27.60m + 15.0 m	27.60m + 15.0 m	27.60m + 15.0 m	
	0°	0°	15°	30°	0°	15°	30°	
								
7.0								7.0
8.0	3.80	4.10						8.0
9.0	3.80	3.95						9.0
10.0	3.80	3.65	3.10					10.0
11.0	3.55	3.35	2.90		1.95			11.0
12.0	3.30	3.10	2.75	2.45	1.90			12.0
13.0	3.05	2.90	2.60	2.35	1.85			13.0
14.0	2.85	2.75	2.45	2.25	1.75	1.35		14.0
15.0	2.70	2.60	2.30	2.15	1.70	1.30		15.0
16.0	2.50	2.40	2.20	2.05	1.60	1.30		16.0
17.0	2.40	2.30	2.10	1.95	1.55	1.25	1.05	17.0
18.0	2.20	2.20	2.00	1.90	1.50	1.20	1.00	18.0
19.0	2.15	1.90	1.90	1.80	1.45	1.20	1.00	19.0
20.0	2.00	1.70	1.70	1.70	1.40	1.15	1.00	20.0
21.0	1.85	1.50	1.50	1.50	1.35	1.10	0.95	21.0
22.0	1.60	1.40	1.40	1.40	1.30	1.10	0.95	22.0
23.0	1.45	1.30	1.30	1.30	1.25	1.05	0.95	23.0
24.0	1.20	1.20	1.20	1.20	1.25	1.05	0.90	24.0
25.0	1.05	1.10	1.10	1.10	1.20	1.00	0.90	25.0
26.0	0.90	1.00	1.00	1.00	1.10	1.00	0.90	26.0
27.0	0.80	0.90	0.90	0.90	1.00	1.00	0.85	27.0
28.0	0.70	0.80	0.80	0.80	0.90	0.95	0.85	28.0
29.0	0.60	0.70	0.70	0.70	0.80	0.95	0.85	29.0
30.0	0.50	0.60	0.60	0.60	0.70	0.90	0.85	30.0
31.0								31.0
32.0								32.0



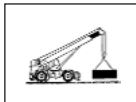
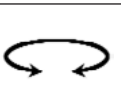

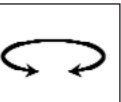





# GRU FUORISTRADA

# modello A 350

							
14.00R24	0 Km/h	360°	0 Km/h	0°	2 Km/h	0°	

									
	8.80 m	12.00 m	8.80 m	12.00 m	15.10 m	8.80 m	12.00 m	15.10 m	
									
3.0			15.40						3.0
3.5			14.00	12.10					3.5
4.0			13.60	12.10	9.10				4.0
4.5			12.05	12.10	9.10	9.10	9.10		4.5
5.0	4.80		10.80	10.85	9.10	8.20	8.20		5.0
6.0	3.40	3.50	7.80	7.80	7.80	6.80	6.80	6.80	6.0
7.0	2.50	2.50	5.80	6.00	6.00	5.50	5.50	5.50	7.0
8.0		1.80		4.60	4.70		4.30	4.30	8.0
9.0		1.30		3.60	3.60		3.40	3.40	9.0
10.0		0.90		2.90	2.90		2.70	2.70	10.0
11.0					2.40			2.20	11.0
12.0					1.90			1.80	12.0
13.0					1.50			1.40	13.0
14.0									14.0

							
16.00R25	0 Km/h	360°	0 Km/h	0°	2 Km/h	0°	

									
	8.80 m	12.00 m	8.80 m	12.00 m	15.10 m	8.80 m	12.00 m	15.10 m	
									
3.0			15.40						3.0
3.5			14.00	12.10					3.5
4.0			13.60	12.10	9.10				4.0