

modello

# COMPACT 10N

**MinoEge**  
www.minoege.it

CENTRO PRENOTAZIONI  
**0421 290573**

## VERTICALI

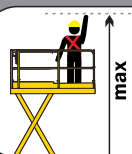
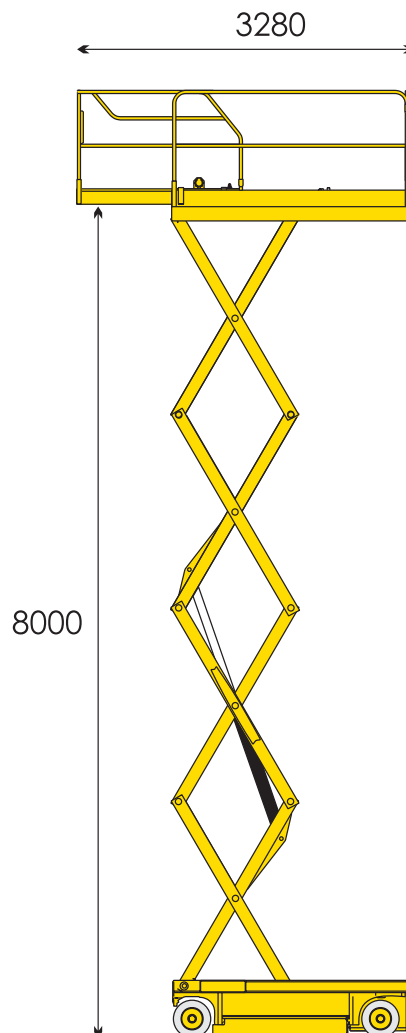
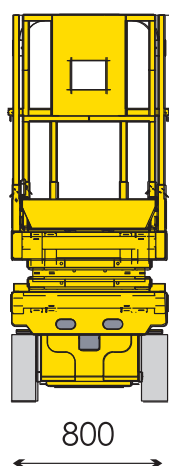
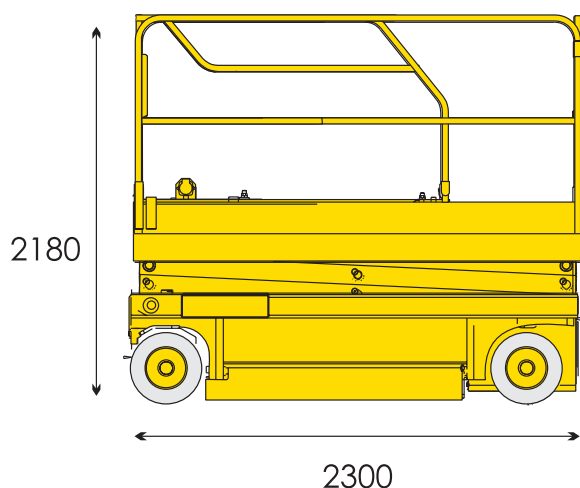

10,00



230 KG

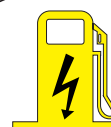

ELETTRICA

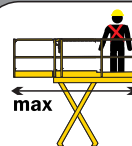

3,22

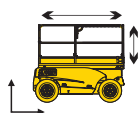

2,18x0,8 m



23%

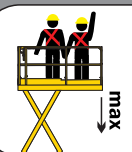

8,00

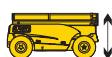

1,33

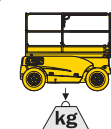

2160 KG

www.minoege.it