

modello

# COMPACT 12

**MinoEge**  
www.minoege.it

CENTRO PRENOTAZIONI  
**0421 290573**

## VERTICALI

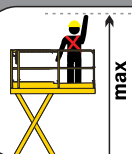
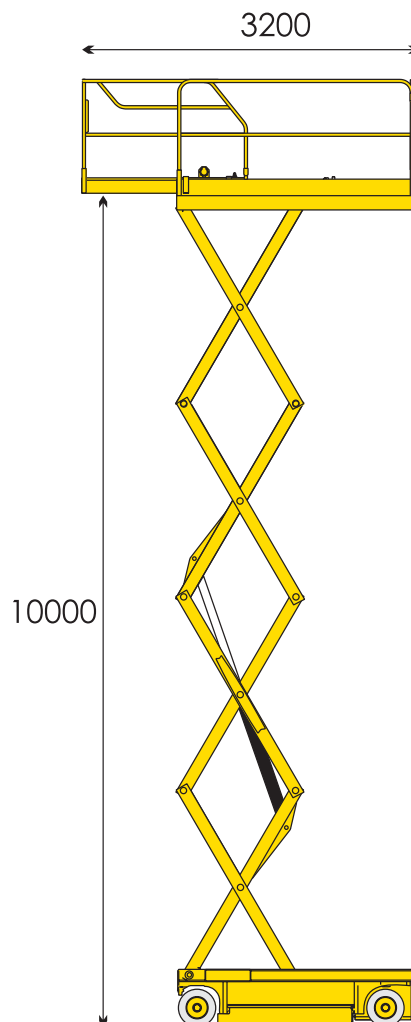
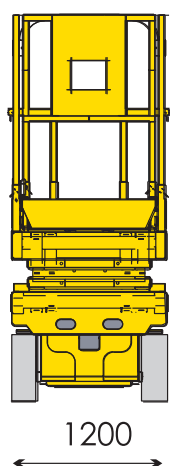
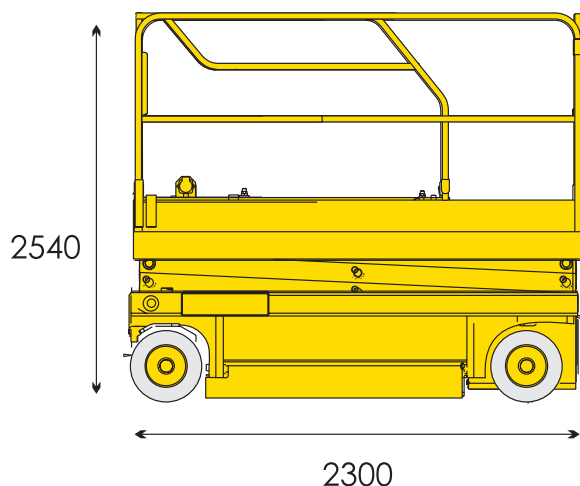

12,00



300 KG

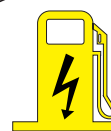

ELETTRICA



3,20

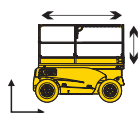

2,30x1,20 m



23%



10,00

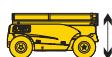

1,26

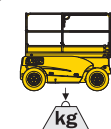

2630 KG